

Systemhöhe 35 mm mit Rasterleiste

1.1.1

zum Einbau in jede Schublade, Wanne, Modul
to install in each drawer, tray ...
à installer dans chaque tiroir, bac ...

Systemheight 35 mm with slotted rail holder
Hauteur Système 35 mm avec listeau à crans

- einfache Montage
 - Teiler aufstecken und verschieben
 - Teiler mit integrierten Kartentaschen
- simple installation
- clip and slide
- dividers with integrated card holders
- montage facile
- clipper et coulisser
- séparateurs avec porte-cartes intégrés



x = Länge nach Wunsch

x = made to measure

x = couper sur mesure

(A) Rasterleisten / Slotted Rail Holders / Listeaux à crans

RL 500/35-3 N° 220102N

Rasterleiste Kunststoff transparent, mit doppelseitigem Klebeband, Klemmweite 3 mm
Slotted Rail Holder, plastics clear, with double sided adhesive tape, width of the clamp 3 mm
Listeau à crans, plastique transparent, avec ruban adhésif, distance 3 mm

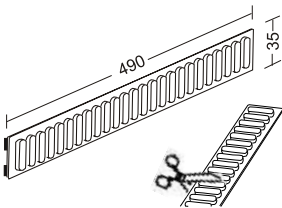

(B) Schienen / Rails / Séparateurs longitudinaux

US 35/3 N° 200103
Universalschiene Alu
Rail aluminium
Rail en aluminium

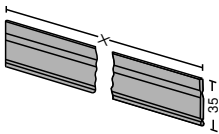

USP 35/3 N° 210127
Universalschiene Acryl
Acrylic rail
Rail en plastique

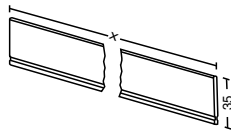

US 105 S/600 N° 210155
Universalschiene SAN
Rail SAN
Rail en SAN

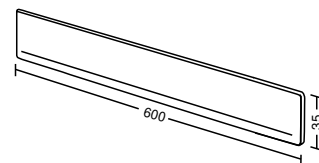

(C) Universalteiler / Sliding dividers / Séparateurs coulissants

UT 105 K/120 mm N° 240160
Universalteiler Kunststoff
Sliding divider plastics
Séparateur coulissant

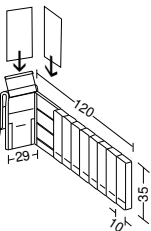

UT 105 G/140 mm N° 240160
UT 105 G/170 mm N° 240161
UT 105 G/200 mm N° 240162
Universalteiler Kunststoff
Sliding divider plastics
Séparateur coulissant

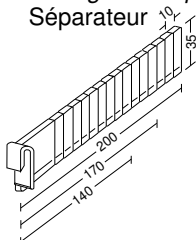

UT 105 G/300 mm N° 240151
UT 105 G/400 mm N° 240152
Universalteiler Kunststoff
Sliding divider plastics
Séparateur coulissant

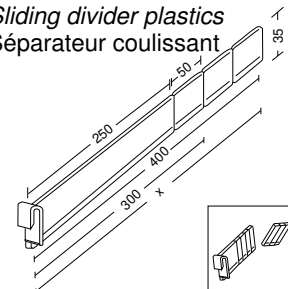



Systemhöhe 35 mm mit Rasterleiste

Systemheight 35 mm with slotted rail holder
Hauteur Système 35 mm avec listeau à crans

D Clips

L-Clip 20/35 R N° 240504

L-Clip
L-Clip
Clip en L

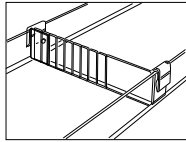
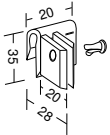

Gegenclip für größere Stabilität
Clip opposed for better stability
Clip opposé pour meilleur stabilité

Kartentaschen / Card holders / Porte cartes

BK 35/3-5 N° 100045

Kartentasche Kunststoff
Card holder plastics
Porte-carte plastique

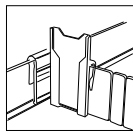
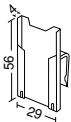

auf Teiler aufgesteckt
stack on the divider
mis sur le séparateur

BK 35/9 N° 100046

Kartentasche Kunststoff
Card holder plastics
Porte-carte plastique

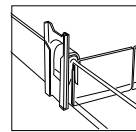
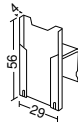

auf Klammer aufgesteckt
stack on the clip
mis sur le clip

Geben Sie uns die **Innenmaße** bekannt
Please insert the **inside dimensions**
Veuillez nous donner les **dimensions internes**

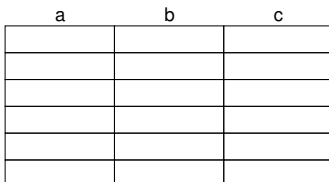

Ihre **Wunschunterteilung**
Your drawing
Votre esquisse

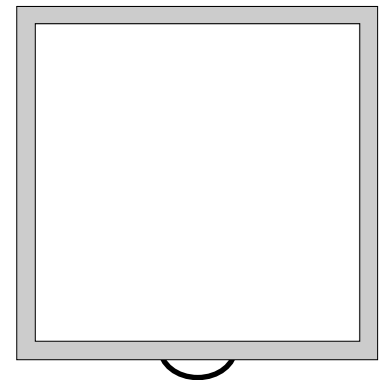
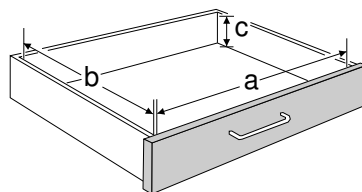

z.B.: Unterteilung längs orientiert

e.g.: Division lengthwise

p.ex.: Séparation longitudinale

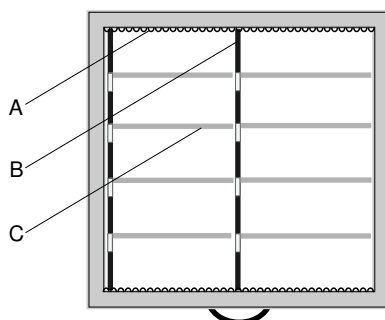

Unterteilung quer orientiert

Division crosswise

Séparation transversale

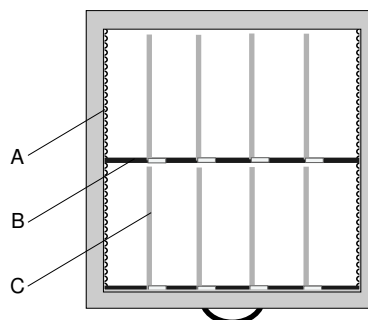

etc. ...

Tailor-made solutions

Solutions spéciales

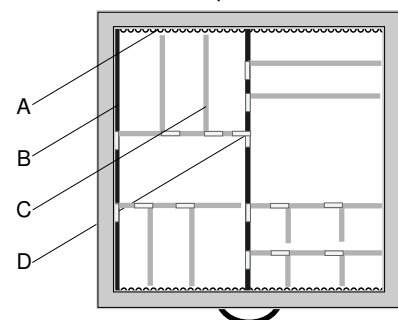

Systemhöhe 55 mm mit Rasterleiste

1.1.3

zum Einbau in jede Schublade, Wanne, Modul
to install in each drawer, tray ...
à installer dans chaque tiroir, bac ...

Systemheight 55 mm with slotted rail holder
Hauteur Système 55 mm avec listeau à crans

- einfache Montage
- Teiler aufstecken und verschieben
- Teiler mit integrierten Kartentaschen

- simple installation
- clip and slide
- dividers with integrated card holders

- montage facile
- clipper et coulisser
- séparateurs avec porte-cartes intégrés



x = Länge nach Wunsch

x = made to measure

x = couper sur mesure

A Rasterleisten / Slotted Rail Holders / Listeaux à crans

RL 500/35-3 N° 220102N

RL 500/55-3 N° 220101N

Rasterleiste Kunststoff transparent, mit doppelseitigem Klebeband, Klemmweite 3 mm

Slotted Rail Holder, plastics clear, with double sided adhesive tape, width of the clamp 3 mm

Listeau à crans, plastique transparent, avec ruban adhésif, distance 3 mm

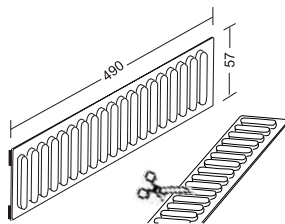
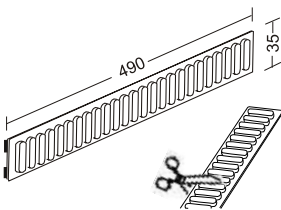

B Schienen / Rails / Séparateurs longitudinaux

US 55/3 N° 200101
Universalschiene Alu
Rail aluminium
Rail en aluminium

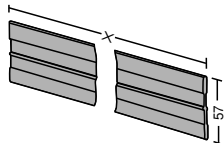

USP 55/3 N° 210130
Universalschiene Acryl
Acrylic rail
Rail en plastique

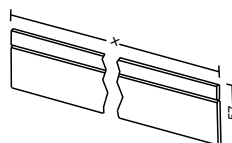

US 104 S/600 N° 210145
Universalschiene SAN
Rail SAN
Rail en SAN

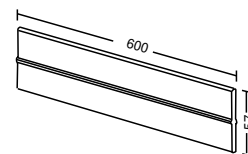

C Universalteiler / Sliding dividers / Séparateurs coulissants

Universalteiler Kunststoff
Sliding divider plastics
Séparateur coulissant

UT 104 GS/77 mm N° 240070
UT 104 GS/170 mm N° 240077

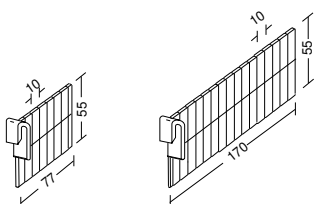

UT 104 KS/77 mm N° 240080
UT 104 KS/110 mm N° 240081
UT 104 KS/120 mm N° 240082
UT 104 KS/130 mm N° 240083
UT 104 KS/140 mm N° 240084
UT 104 KS/170 mm N° 240087
UT 104 KS/200 mm N° 240088

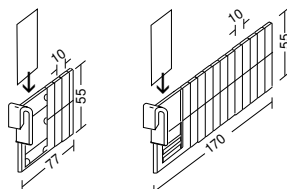

UT 104 G/330 mm N° 240103
UT 104 K/330 mm N° 240104

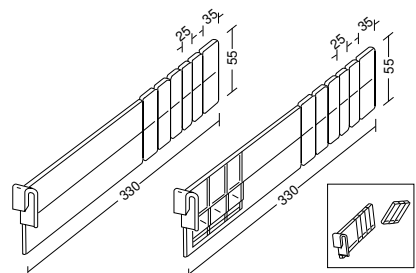



Systemhöhe 55 mm mit Rasterleiste

Systemhöhe 55 mm with slotted rail holder
Hauteur Système 55 mm avec listeau à crans

D Clips

L-Clip 20/35 R N° 240504

L-Clip
L-Clip
Clip en L

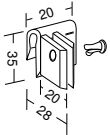

L-Clip 45/55 R N° 240508

L-Clip oben geschlossen
L-Clip
Clip en L

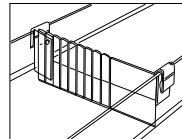
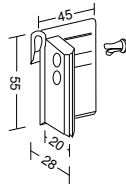

Gegenclip für größere Stabilität
Clip opposed for better stability
Clip opposé pour meilleur stabilité

Kartentaschen / Card holders / Porte cartes

BK 35/3-5 N° 100045

Kartentasche Kunststoff
Card holder plastics
Porte-carte plastique

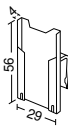

BK 55/3-5 N° 100047

Kartentasche Kunststoff
Card holder plastics
Porte-carte plastique

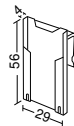

BK 55/9 N° 100048

Kartentasche Kunststoff
Card holder plastics
Porte-carte plastique

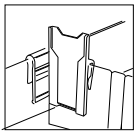
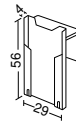

auf Teiler aufgesteckt
stack on the divider
mis sur le séparateur

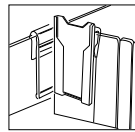

auf Teiler aufgesteckt
stack on the divider
mis sur le séparateur

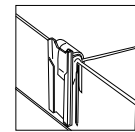

auf Klammer aufgesteckt
stack on the clip
mis sur le clip

Geben Sie uns die **Innenmaße** bekannt
Please insert the **inside dimensions**
Veuillez nous donner les **dimensions internes**

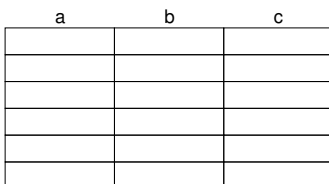

Ihre **Wunschunterteilung**
Your drawing
Votre esquisse

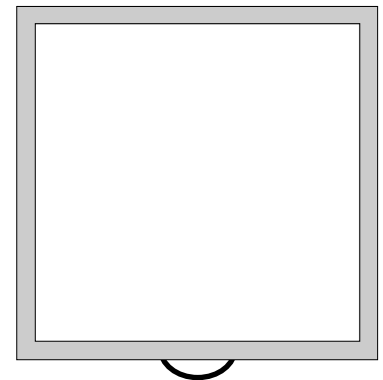
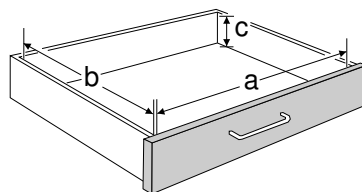

z.B.: Unterteilung längs orientiert

e.g.: Division lengthwise

p.ex.: Séparation longitudinale

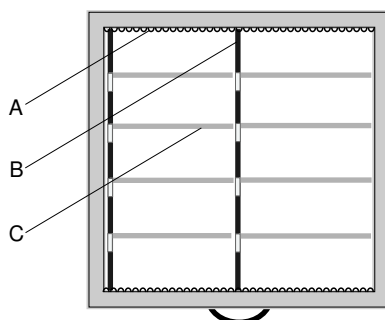

Unterteilung quer orientiert

Division crosswise

Séparation transversale

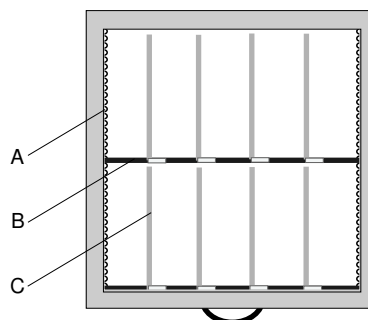

etc. ...

Tailor-made solutions

Solutions spéciales

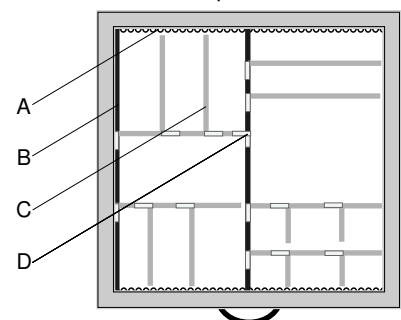

Systemhöhe 100 mm mit Rasterleiste

1.1.4

zum Einbau in jede Schublade, Wanne, Modul
to install in each drawer, tray ...
à installer dans chaque tiroir, bac ...

Systemheight 100 mm with slotted rail holder
Hauteur Système 100 mm avec listeau à crans

- einfache Montage
- Teiler aufstecken und verschieben
- Teiler mit integrierten Kartentaschen

- simple installation
- clip and slide
- dividers with integrated card holders

- montage facile
- clipper et coulisser
- séparateurs avec porte-cartes intégrés

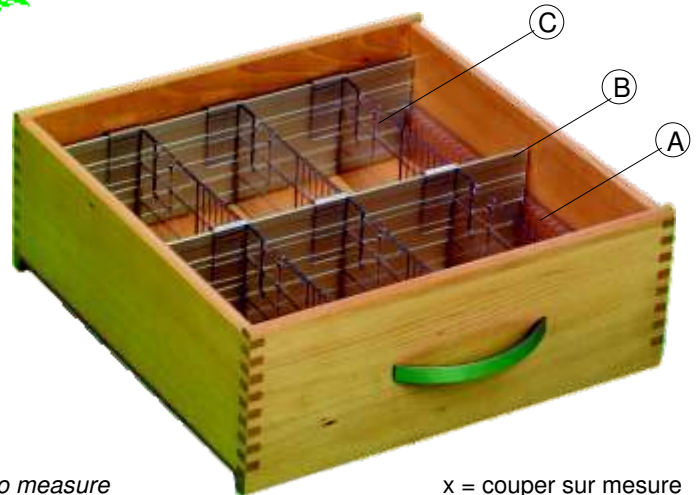

x = Länge nach Wunsch

x = made to measure

x = couper sur mesure

A Rasterleisten / Slotted Rail Holders / Listeaux à crans

RL 500/55-3 N° 220101N

Rasterleiste Kunststoff transparent, mit doppelseitigem Klebeband, Klemmweite 3 mm
Slotted Rail Holder, plastics clear, with double sided adhesive tape, width of the clamp 3 mm
Listeau à crans, plastique transparent, avec ruban adhésif, distance 3 mm

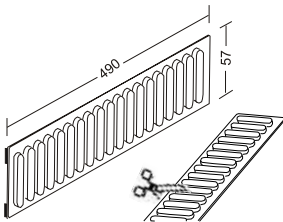

B Schienen / Rails / Séparateurs longitudinaux

US 100/3 N° 200100
Universalschiene Alu
Rail aluminium
Rail en aluminium

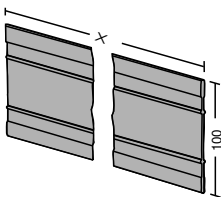

USP 100/3 N° 210138
Universalschiene Acryl
Acrylic rail
Rail en plastique

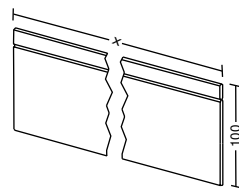

FS 100/3 PC 533 N° 7820102
Flexschiene PC
Flexrail PC
Flexrail PC

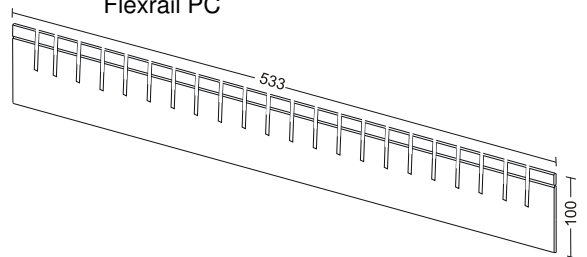

C Universalteiler / Sliding dividers / Séparateurs coulissants

Universalteiler Kunststoff
Sliding divider plastics
Séparateur coulissant

UT 100/100 GL 170 mm N° 240820
UT 100/100 GL 180 mm N° 240824
UT 100/100 GL 190 mm N° 240828
UT 100/100 GL 300 mm N° 240850

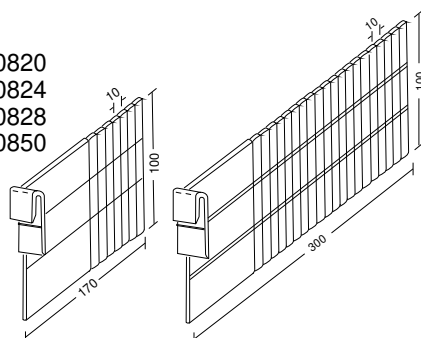

UT 100/100 KL 170 mm N° 240821
UT 100/100 KL 300 mm N° 240851

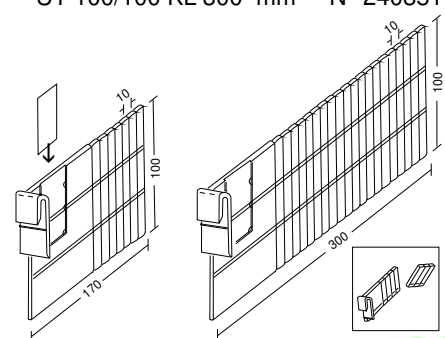



Systemhöhe 100 mm mit Rasterleiste

Systemheight 100 mm with slotted rail holder
Hauteur Système 100 mm avec listeau à crans

D Clips

L-Clip 45/55 R N° 240508
L-Clip oben geschlossen
L-Clip
Clip en L

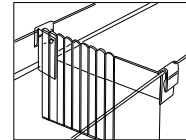
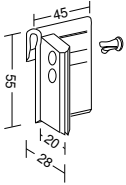

Gegenclip für größere Stabilität
Clip opposed for better stability
Clip opposé pour meilleur stabilité

Kartentaschen / Card holders / Porte cartes

BK 35/3-5 N° 100045
Kartentasche Kunststoff
Card holder plastics
Porte-carte plastique

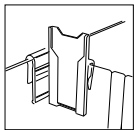
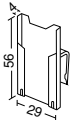

auf Teiler aufgesteckt
stack on the divider
mis sur le séparateur

BK 55/3-5 N° 100047
Kartentasche Kunststoff
Card holder plastics
Porte-carte plastique

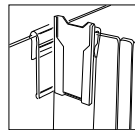
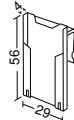

auf Teiler aufgesteckt
stack on the divider
mis sur le séparateur

BK 55/9 N° 100048
Kartentasche Kunststoff
Card holder plastics
Porte-carte plastique

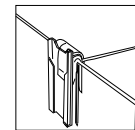
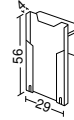

auf Klammer aufgesteckt
stack on the clip
mis sur le clip

Geben Sie uns die **Innenmaße** bekannt
Please insert the **inside dimensions**
Veuillez nous donner les **dimensions internes**

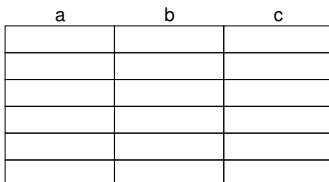

Ihre Wunsunterteilung
Your drawing
Votre esquisse

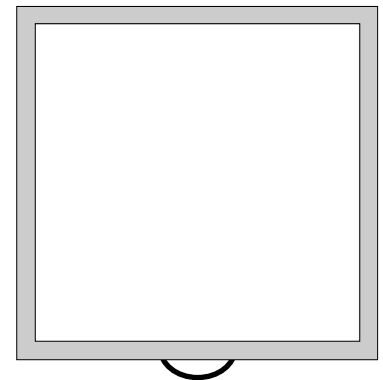
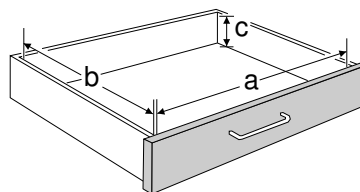

z.B.: Unterteilung längs orientiert
e.g.: Division lengthwise
p.ex.: Séparation longitudinale

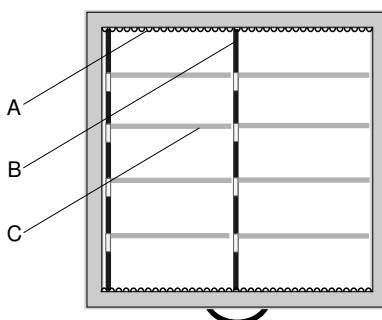

Unterteilung quer orientiert
Division crosswise
Séparation transversale

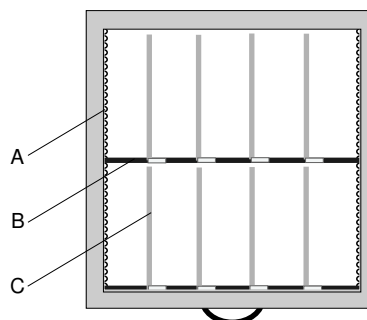

etc. ...
Tailor-made solutions
Solutions spéciales

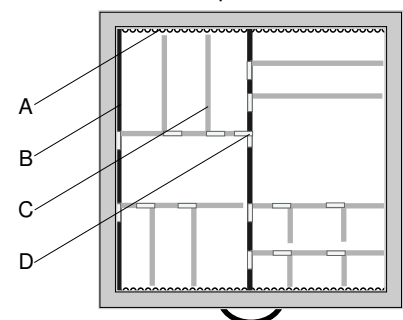

zum Einbau in jede Schublade, Wanne, Modul
 to install in each drawer, tray ...
 à installer dans chaque tiroir, bac ...

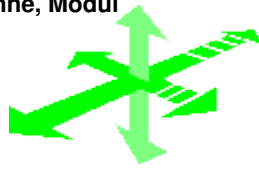

- einfache Montage
- Teiler aufstecken und verschieben

- simple installation
- clip and slide

- montage facile
- clipper et coulisser

Heights customised for insert for drawers
 Hauteurs intermédiaires pour insert pour tiroir

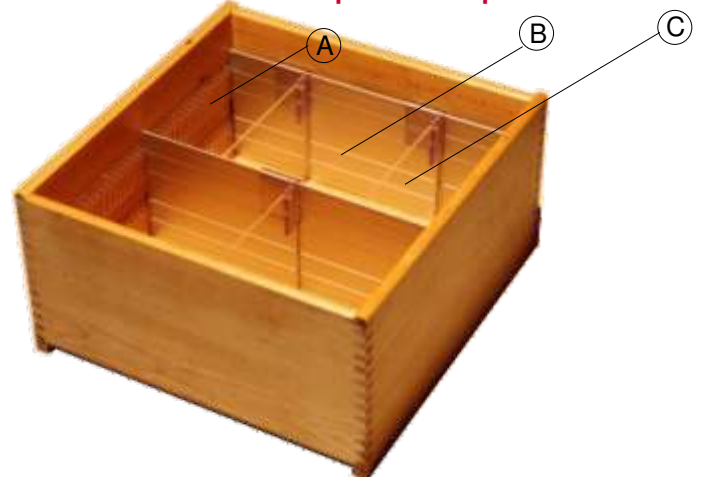

x = Länge nach Wunsch

x = made to measure

x = couper sur mesure

A Rasterleisten / Slotted Rail Holders / Listeaux à crans

RL 500/55-3 N° 220101N

Rasterleiste Kunststoff transparent, mit doppelseitigem Klebeband, Klemmweite 3 mm
 Slotted Rail Holder, plastics clear, with double sided adhesive tape, width of the clamp 3 mm
 Listeau à crans, plastique transparent, avec ruban adhésif, distance 3 mm

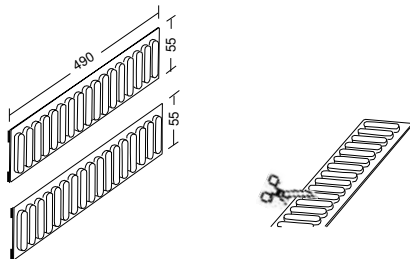

B Schienen / Rails / Séparateurs longitudinaux

USP

Universalschiene Acryl

Acrylic rail

Rail en plastique

Länge x / Höhe x

Length x / Height x

Longuer x / Hauteur x

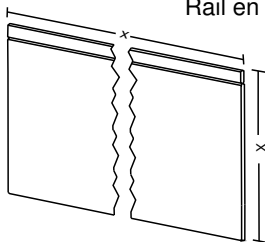

C Universalteiler / Sliding dividers / Séparateurs coulissants

Länge x / Höhe x

Length x / Height x

Longuer x / Hauteur x

Universalteiler Acryl

Acrylic sliding divider

Séparateur coulissant acrylique

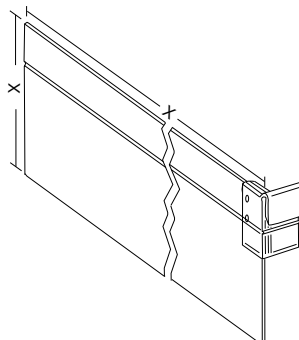

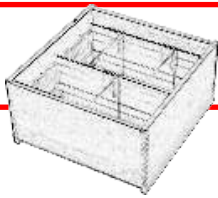

Zwischenhöhen mit Rasterleiste

Heights customised for insert for drawers
Hauteurs intermédiaires pour insert pour tiroir

D Clips

L-Clip 45/55 R N° 240508
L-Clip oben geschlossen
L-Clip
Clip en L

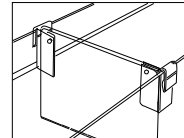
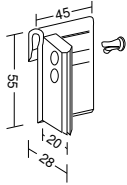

Gegenclip für größere Stabilität
Clip opposed for better stability
Clip opposé pour meilleur stabilité

Kartentaschen / Card holders / Porte cartes

BK 55/3-5 N° 100047
Kartentasche Kunststoff
Card holder plastics
Porte-carte plastique

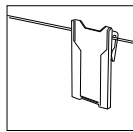
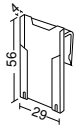

auf Teiler aufgesteckt
stack on the divider
mis sur le séparateur

BK 55/9 N° 100048
Kartentasche Kunststoff
Card holder plastics
Porte-carte plastique

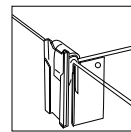
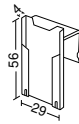

auf Klammer aufgesteckt
stack on the clip
mis sur le clip

Geben Sie uns die **Innenmaße** bekannt
Please insert the **inside dimensions**
Veuillez nous donner les **dimensions internes**

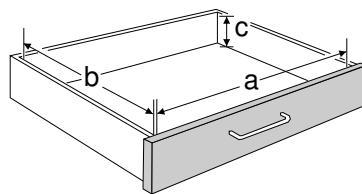
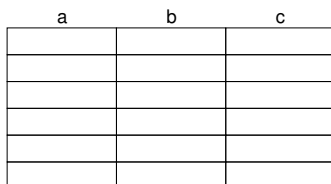

Ihre **Wunschunterteilung**
Your drawing
Votre esquisse

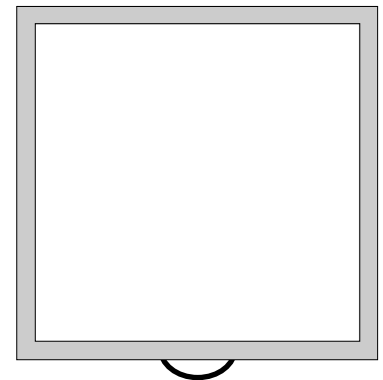

z.B.: Unterteilung längs orientiert
e.g.: Division lengthwise
p.ex.: Séparation longitudinale

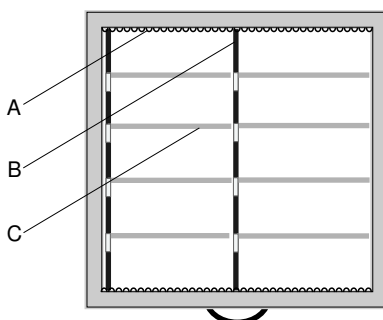

Unterteilung quer orientiert
Division crosswise
Séparation transversale

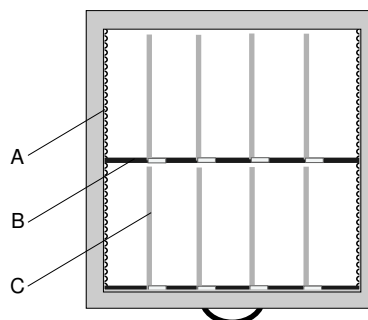

etc. ...
Tailor-made solutions
Solutions spéciales

